

ISSN 2310-6697

toiser—open transactions on independent scientific-engineering research

FUNKTECHNIKPLUS # JOURNAL

Théorie—Expérimentation—Métrologie—Logiciel—Applications

ISSUE 7 – SUNDAY 31 MAY 2015 – YEAR 2

REPRINT

A Planar Delta-Cross Shaped Loop Antenna: Analysis and Simulation – The 2 WL Case

G.A. Papadaniel, N.I. Yannopoulou, P.E. Zimourtopoulos



*This small European Journal is
In the Defense of Honesty in Science and Ethics in Engineering*

Publisher – otoiser—open transactions on independent scientific engineering research, www.otoiser.org—info@otoiser.org, Hauptstraße 52, 2831 Scheiblingkirchen, Austria

Language – We declare the origins of the Journal by using in the cover page English, German and French, as well as, a Hellenic vignette. However, since we recognize the dominance of US English in the technical literature, we adopted it as the Journal's language, although it is not our native language.

Focus – We consider Radio–FUNK, which still creates a vivid impression of the untouchable, and its Technology–TECHNIK, from an Advanced–PLUS point of view, Plus–PLUS Telecommunications Engineering, Electrical Engineering and Computer Science, that is, we dynamically focus at any related scientific-engineering research regarding Théorie, Expérimentation, Métrologie, Logiciel, ou Applications.

Scope – We emphasize this scope broadness by extending the title of the Journal with a Doppelkreuz-Zeichen # which we use as a placeholder for substitution of our Editorial Team disciplines: # Telecommunications etc. as above, or # High Voltage, # Software Engineering, # Simulation etc. as below.

Frequency – We publish 3 issues per year: on 31st of January, on 31st of May, and on 30th of September, as well as, an extra issue every 3 papers and a volume every 2 years.

Editions – We increase the edition number of an issue only when is needed to reform one or more of its papers—thus to increase their version numbers—but we keep unchanged its 1st edition date shown on its front page and we number its pages sequentially from 1. We count the editions of *About* separately.

Format – We use a fixed-space font, hyphenation, justification, unfixed word spacing, and the uncommon for Journals A5 (half A4) page size to achieve WYSIWYG printing and clear reading of 2 to 4 side-by-side pages on wide-screen displays

Printing-on-Demand – We can email gratis PDFs at 300-4000 dpi in booklet page scaling of either brochure or book type.

Copyright – We publish under a Creative Commons Attribution, CC-BY 3.0 Unported or CC-BY 4.0 International, License only.

Please download the latest *About* edition from
about.ftpj.otoiser.org

Editorial Team

Electrical Engineering

High Voltage Engineering # Insulating Materials
Professor Michael Danikas, mdanikas@ee.duth.gr
EECE, Democritus University of Thrace, Greece

Electrical Machines # Renewable Energies # Electric Vehicles
Assistant Professor Athanasios Karlis, akarlis@ee.duth.gr
EECE, Democritus University of Thrace, Greece

Computer Science

Computer Engineering # Software Engineering # Cyber Security
Professor Vasilis Katos, vkatos@bournemouth.ac.uk
Head of Computer and Informatics Dept, Bournemouth Univ, UK

Internet Engineering # Learning Management Systems
Lecturer Sotirios Kontogiannis, skontog@gmail.com
Business Administration Dept, TEI, Western Macedonia, Greece

Hypercomputation # Fuzzy Computation # Digital Typography
Dr. Apostolos Syropoulos, asyropoulos@yahoo.com
BSc-Physics, MSc-Computer Science, PhD-Computer Science
Independent Researcher, Xanthi, Greece

Telecommunications Engineering

Applied EM Electromagnetics # Applied Mathematics
Dr. Nikolaos Berketis, nberketis@gmail.com
BSc-Mathematics, MSc-Applied Maths, PhD-Applied Mathematics
Independent Researcher, Athens, Greece

Antennas # Metrology # EM Software # Simulation # Virtual Labs

Applied EM # Education # FLOSS # Amateur Radio # Electronics
Dr. Nikolitsa Yannopoulou, yin@arg.op4.eu *
Diploma Eng-EE, MEng-Telecom-EECE, PhD-Eng-Antennas-EECE
Independent Researcher, Scheiblingkirchen, Austria

Dr. Petros Zimourtopoulos, pez@arg.op4.eu *
BSc-Physics, MSc-Radio-Electronics, PhD-Antennas-EE
Independent Researcher, Scheiblingkirchen, Austria

* Copy & Layout Editing – Proof Reading – Issue & Web Management

Technical Support

Konstantinos Kondylis, kkondylis@gmail.com
Diploma Eng-EECE, MEng-EECE, Doha, Qatar

Christos Koutsos, ckoutsos@gmail.com
Diploma Eng-EECE, MEng-EECE, Bratislava, Slovakia

Information for Authors

This is a small, but independent, low profile Journal, in which we are all—Authors, Reviewers, Readers, and Editors—free at last to be Peers in Knowledge, without suffering from Journal roles or positions, Professional–Amateur–Academic statuses, or established "impact factorizations", under the following guiding principles:

Authors – We know what Work means, we respect the Work of the Independent Researcher in Science and Engineering and we want to exhibit his Work. Thus, we decided to found this Free and Open Access Journal in which to publish this Work. Furthermore, as we care indeed for the Work of the technical author—especially a young or a beginner one—we strongly support the publication of his Work, as follows:

- 0 We do not demand from the author to transfer his own copyright to us. Instead, we only consider papers resulting from original research work only, and only if the author can assure us that he owns the copyright of his own paper as well as that he submits to the Journal either an original copy or a revised version of his own paper, for possible publication after review—or even for immediate republication, if this paper has already been published after review—but, in any case under a Creative Commons Attribution, CC-BY 3 Unported or CC-BY 4 International, License, only.
- 1 We encourage the author to submit his own paper written just in Basic English plus Technical Terminology.
- 2 We encourage the author even to select a pen name, which may drop it at any time to reveal his identity.
- 3 We encourage the author to submit an accepted for publication paper, which he was forced to decline that publication because it would be based on a review with unacceptable evaluation or derogatory comments.
- 4 We encourage the author to submit any paper that was rejected after a poor, impotent, inadequate, unreasonable, irresponsible, incompetent, or "just ticking" review.
- 5 We encourage the author to submit an unreviewed paper of his own that he uploaded on some Open Access repository.
- 6 We encourage the author to upload his published papers in our Journal to a truly Free Open repository like viXra.org.
- 7 We provide the author with a decent, express, peer review process, of up to just 4 weeks, by at least 2, either anonymous or onymous, reviewers.

- 8 We provide the author with the option to choose from 2 review processes: the traditional, anonymous, close one, as well as, a contemporary, onymous, open review in our private mailing list for Peer Discussion.
- 9 Under the Clause 0 : We immediately accept for publication a research paper directly resulting from a Project Report, or a Diploma-, Master-, or PhD-thesis, which already the author has successfully defended before a committee of experts, as long as he can mention 2 members of this committee who approved his Work.
- 10 Under the Clause 0 : We immediately accept for publication any paper which is not Openly Accessible on the Internet.
- 11 We immediately publish online a paper, as soon as it is accepted for publication in the Journal.
- 12 We quickly publish an extra issue—that is in excess of the 3 issues we publish a year—as soon as the review process of 3 papers is completed.

Reviewers – Every peer may voluntarily become a reviewer of the Journal in his skillfulness for as long as he wishes. In addition, each author of the Journal must review one paper in his expertness for each one of his published papers.

Readers – Every reader is a potential post-reviewer: we welcome comments and post-reviews in our private mailing list for Peer Discussion.

Editors – Every editor owns a PhD degree—to objectively prove that he really has the working experience of passing through the dominant publishing system. An editor pre-reviews a paper in order to check its compliance to our guiding principles and to select the appropriate reviewers of it. We can accept for consideration papers only in the expertise areas currently shown in the Editorial Team page, above. However, since we are very willing to amplify and extend the Scope of the Journal, we welcome the volunteer expert, in any related subject, who wants to join the Editorial Team as long as he unreservedly accepts our guiding principles.

Electronic Publishing

We regularly use the Free Libre Open Source Software Libre Office with the Free Liberation Mono font and the Freewares PDFCreator and PDF-Xchange Viewer. We also use, with some basic html code of ours: the Free Open Source Software Open Journal System OJS by the Public Knowledge Project PKP installed in our website, and the Free Open Digital Library of

About

Internet Archive website, where we upload Issues, Paper reprints, *About* documents, and Volumes, in both portrait and landscape orientations, for exceptionally clear online reading with the Free Open Source BookReader.

Submissions

We can consider only papers submitted in a format which is fully compatible with LibreOffice—preferably in odt format.

Legal Notice – It is taken for granted that the submitter–correspondent author accepts, without any reservation, the totality of our publication conditions as they are analytically detailed here, in this *About*, as well as, that he also carries, in the case of a paper by multiple authors, the independent will of each one of his coauthors to unreservedly accept all the aforementioned conditions for their paper.

Internet Addresses

Internet Publishing Website : ftpj.otoiser.org

Internet Archive Digital Library : archive.org/details/@ftpj

Printing-on-Demand : pod@ftpj.otoiser.org

Principal Contact : principal-contact@ftpj.otoiser.org

Technical Support : technical-support@ftpj.otoiser.org

Editorial Team–Technical Support List : etts.ftpj.otoiser.org

Peer Discussion List : peers.ftpj.otoiser.org

Submissions : sub@ftpj.otoiser.org

Sample Paper Template : template.ftpj.otoiser.org

ARG NfP AoI

Antennas Research Group

Not-for-Profit Association of Individuals *

arg.op4.eu – arg@op4.eu

Hauptstraße 52, 2831 Scheiblingkirchen, Austria

* The Constitution of Greece, Article: 12(3) 2008:

www.hellenicparliament.gr/en/Vouli-ton-Ellinon/To-Politevma

* The Hellenic Supreme Court of Civil and Penal Law:

www.areiospagos.gr/en/ – Court Rulings:Civil|A1|511|2008

This document is licensed under a Creative Commons Attribution 4.0 International License – <https://creativecommons.org/licenses/by/4.0/>

A Planar Delta-Cross Shaped Loop Antenna: Analysis and Simulation - The 2 WL Case

G.A. Papadaniel, N.I. Yannopoulou, P.E. Zimourtopoulos *

[1] Independent Researcher, Thessaloniki, Greece
[2, 3] Antennas Research Group, Hellas – Austria

Abstract

A planar Delta-Cross shaped loop antenna is proposed. The presentation includes results from an analytic study of the radiation pattern, as well as, from a simulation study for both the electric and radiation characteristics: input impedance, standing wave ratio, radiation pattern and directivity. The loop was initially shaped as 4 non-overlapping equilateral triangles on a plane, symmetrically oriented around a common vertex, center fed at one triangle base. In order to improve the antenna characteristics, its shape was then modified by equally changing the triangle base angle-while keeping the loop length constant and equal to 2 wavelengths WL. In this way, the final antenna loop was shaped with 4 isosceles triangles. The analytical and simulated results for the radiation pattern were found to be in good agreement. Furthermore, a comparison with antenna's dipole counterpart characteristics showed a much better performance of the proposed antenna.

Keywords

Cross loop antenna, delta elements, analysis, simulation, improvement

Introduction

The cross loop antenna consisting of four delta elements was examined as a prototype antenna during preparation of an EECE diploma thesis [1]. The main available tools for its study were the antenna theory [2], the [RadPat4W] computer program

for antenna patterns [3] the [RICHWIRE] simulation program [4] and the mini-Suite of software tools [5]. Its simple plane figure of double symmetry with respect to two axes which means easy geometrical representation for the theoretical consideration of its radiation pattern as well

as for the simulation and easy construction, was the basic reason for this proposal. The initial antenna consists of four equilateral triangles with side length $\lambda/6$ and almost coincident their four vertices. Thus, the total length of the antenna is 2λ . The feed source was at the middle of the base of one of the triangles as it is shown in Fig. 1.

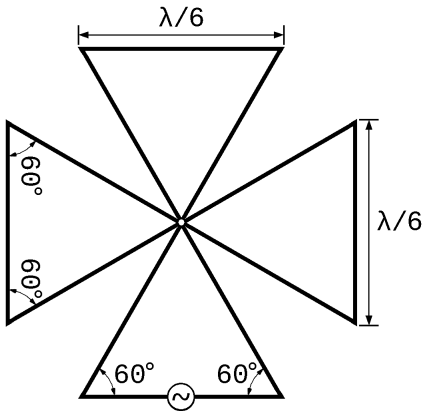

Fig. 1: Planar Delta-Cross Shaped Loop antenna

Then, the antenna was modified only with respect to the base angles of the triangles, keeping constant the triangle perimeter equal to $\lambda/2$, resulting a cross antenna of four isosceles triangles. The angle was varied between 48° and 78° , in order to improve both of its electrical and radiative characteristics and the one with

48° angle was selected as the improved Delta-Cross Shaped Loop antenna.

Analysis

The initial antenna was analytical studied considering standing waves, that is, sinusoidal, current distribution in a parallel wire transmission line. Since the perimeter of each equilateral triangle is $\lambda/2$, the total antenna length is equal to 2λ and it corresponds to a properly formed short circuited transmission line. However, the study was carried out in a $5\lambda/2$ piece of open circuited transmission line, formed properly as in Fig. 2, since the available formula of equation (1) concerns open circuited two parallel wired transmission lines

$$\dot{I}(\ell) = \dot{I} \sin(\beta(h - |\ell|)) \quad (1)$$

with

$$-h \leq \ell \leq +h \text{ where } h = \frac{5}{4}\lambda .$$

The above current distribution (1) was used to evaluate the radiation pattern of the antenna through the relations

$$\vec{E} = e^{i\beta R_{kr}} \text{PF} \begin{bmatrix} \ell_\theta \\ \ell_\varphi \end{bmatrix} \quad (2)$$

$$\text{PF} = \int_{\ell_A}^{\ell_T} \dot{I}(\ell) e^{i\beta \ell_r \ell} d\ell \quad (3)$$

According to the basic standing wave theory: i) the direction of current changes per $\lambda/2$ segment, ii) between two successive standing wave nodes the current phase remains the same and iii) if a source is between two successive standing waves the current direction does not changes. These principles were applied at the properly bended 2-wire transmission line of Fig 2, keeping in mind that the Kirchhoff laws must be simultaneously satisfied.

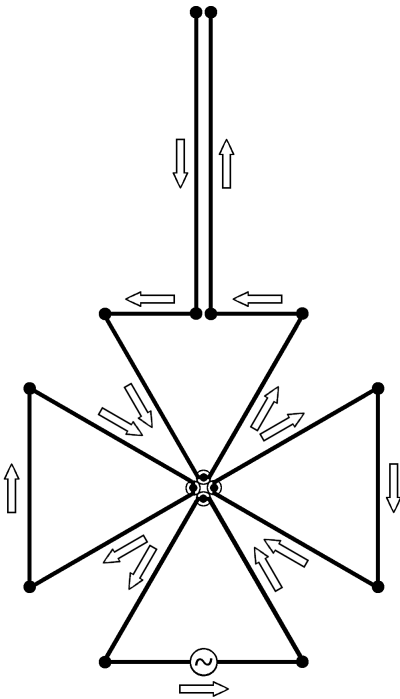

Fig. 2: $5\lambda/2$ properly bended 2-wire transmission line

The double arrows indicate the direction of $i\vec{l}$ product for every one segment, and the dotted circles at the almost coincident vertices of the four equilateral triangles correspond to a zero in the current distribution.

The two parallel $\lambda/4$ segments are almost coincident with opposite currents, so they are mutually canceled as for the radiation and they are excluded from further study. Thus, the remaining segments form the desired antenna, with total length 2λ and a current maximum at the source, as it is shown in Fig. 3.

For every one segment 0-12, of Fig. 3, we had to determine four quantities: the length of its starting point l_A , the length of its end point l_T , the position vector of its center \vec{R}_k , as if they were part of the corresponding line of 2λ length, and its unit direction vector \vec{l}'_i , with its direction to be in all segments from l_A to l_T . The planar antenna was arranged on yOz as it is shown in Fig. 4, along with all the \vec{R}_k position vectors as they were determined by the relation

$$\vec{R}_{k_v} = \vec{O}\vec{A}_v - l_{A_v} \vec{l}'_v \quad (4)$$

and Tab. 1 contains all the above mentioned geometrical quantities.

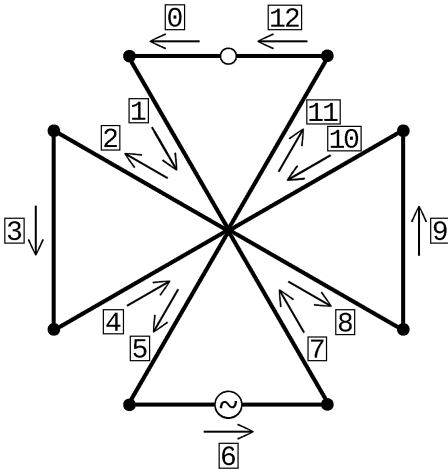

Fig. 3: 13 segments

Then through (1)-(3), that is, after the evaluation of the definite integral for the Pattern Factor PF [2], [6] the radiation pattern of all the 13 segments was formulated and according to the law of superposition the total radiation pattern is given by

$$\begin{aligned} \vec{E} &= \sum_{v=0}^{12} \begin{bmatrix} \dot{E}_{v\theta} \\ \dot{E}_{v\varphi} \end{bmatrix} = \begin{bmatrix} \dot{E}_{\theta} \\ \dot{E}_{\varphi} \end{bmatrix} = \dot{E}_{\theta} \vec{\theta}_i + \dot{E}_{\varphi} \vec{\varphi}_i = \\ &= (E_{\theta_R} + iE_{\theta_I}) \vec{\theta}_i + (E_{\varphi_R} + iE_{\varphi_I}) \vec{\varphi}_i \end{aligned} \quad (5)$$

which, after a lot of symbolic manipulation where the real parts are mutually eliminated, leads to a more simplified expression

$$\vec{E} = \begin{bmatrix} \dot{E}_{\theta} \\ \dot{E}_{\varphi} \end{bmatrix} = i(E_{\theta_I} \vec{\theta}_i + E_{\varphi_I} \vec{\varphi}_i) \quad (6)$$

and by the symmetry of the geometry radiation patterns of 0th, 12th and 6th wire are combined, as well as the five (5) couples: 1, 7 - 2, 8 - 3, 9 - 4, 10 and 5, 11 as it is obvious from Tab. 1. Thus, the total radiation pattern is

$$\begin{aligned} \vec{E} &= \vec{E}_{0,12,6} + \vec{E}_{1,7} + \vec{E}_{2,8} + \\ &+ \vec{E}_{3,9} + \vec{E}_{4,10} + \vec{E}_{5,11} \end{aligned} \quad (7)$$

Simulation

The simulation process was carried out in terms of [RICH-WIRE] program. The center frequency was 1111 [MHz] where the wavelength is $\lambda = 0.27$ [m] and the wire radius was 1 [mm]. We studied the antenna characteristics both electric and electromagnetic (SWR, Input Impedance, Directivity, Radiation Pattern) in the range [600, 1300] MHz around the center frequency with a 10 [MHz] step.

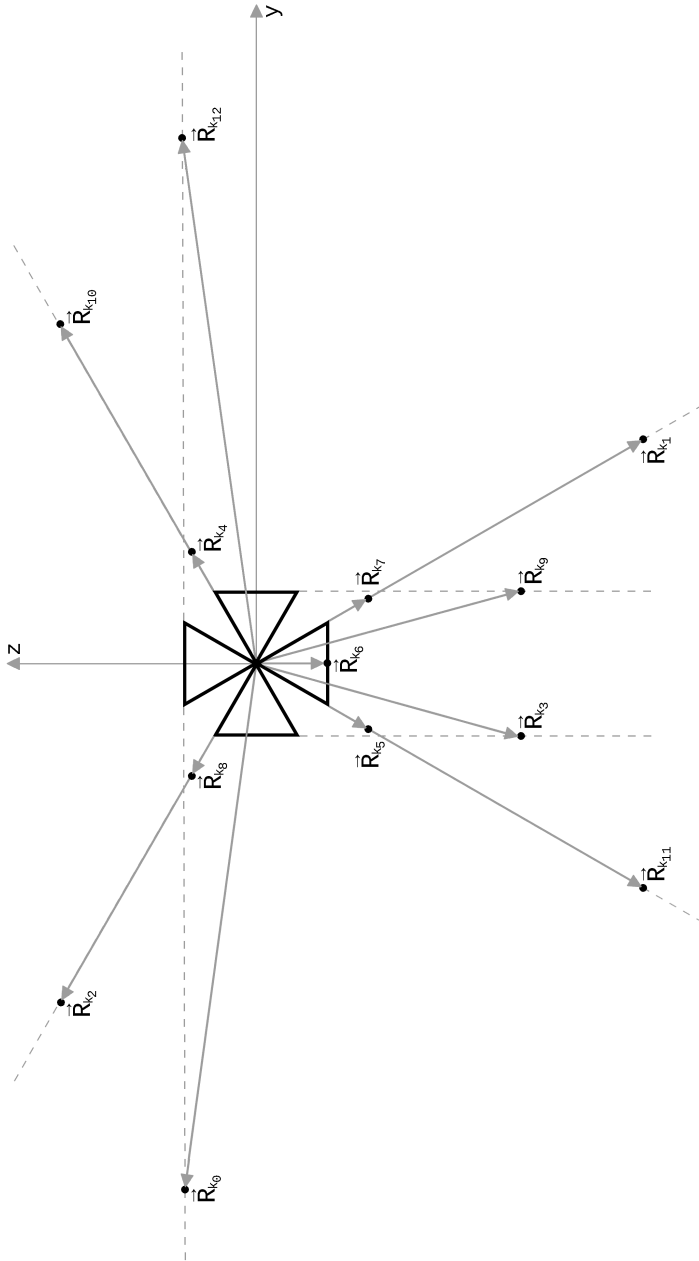

Fig. 4: 13 position vectors

Tab. 1: Geometrical Data

#	ℓ_A	ℓ_T	\vec{R}_k		βR_{k_r}
			\vec{y}_i	\vec{z}_i	
0	$-\lambda$	$-\frac{11}{12}\lambda$	$-\lambda$	$\frac{\sqrt{3}}{12}\lambda$	$-2\pi\sin\theta\sin\varphi + \frac{\sqrt{3}\pi}{6}\cos\theta$
1	$-\frac{11}{12}\lambda$	$-\frac{9}{12}\lambda$	$\frac{3}{8}\lambda$	$-\frac{3\sqrt{3}}{8}\lambda$	$\frac{3\pi}{4}\sin\theta\sin\varphi - \frac{3\sqrt{3}\pi}{4}\cos\theta$
2	$-\frac{9}{12}\lambda$	$-\frac{7}{12}\lambda$	$-\frac{3\sqrt{3}}{8}\lambda$	$\frac{3}{8}\lambda$	$-\frac{3\sqrt{3}\pi}{4}\sin\theta\sin\varphi + \frac{3\pi}{4}\cos\theta$
3	$-\frac{7}{12}\lambda$	$-\frac{5}{12}\lambda$	$-\frac{\sqrt{3}}{12}\lambda$	$-\frac{\lambda}{2}$	$-\frac{\sqrt{3}\pi}{6}\sin\theta\sin\varphi - \pi\cos\theta$
4	$-\frac{5}{12}\lambda$	$-\frac{3}{12}\lambda$	$\frac{\sqrt{3}}{8}\lambda$	$\frac{\lambda}{8}$	$\frac{\sqrt{3}\pi}{4}\sin\theta\sin\varphi + \frac{\pi}{4}\cos\theta$
5	$-\frac{3}{12}\lambda$	$-\frac{\lambda}{12}$	$-\frac{\lambda}{8}$	$-\frac{\sqrt{3}}{8}\lambda$	$-\frac{\pi}{4}\sin\theta\sin\varphi - \frac{\sqrt{3}\pi}{4}\cos\theta$
6	$-\frac{\lambda}{12}$	$\frac{\lambda}{12}$	0	$-\frac{\sqrt{3}}{12}\lambda$	$-\frac{\sqrt{3}\pi}{6}\cos\theta$
7	$\frac{\lambda}{12}$	$\frac{3}{12}\lambda$	$\frac{\lambda}{8}$	$-\frac{\sqrt{3}}{8}\lambda$	$\frac{\pi}{4}\sin\theta\sin\varphi - \frac{\sqrt{3}\pi}{4}\cos\theta$
8	$\frac{3}{12}\lambda$	$\frac{5}{12}\lambda$	$-\frac{\sqrt{3}}{8}\lambda$	$\frac{\lambda}{8}$	$-\frac{\sqrt{3}\pi}{4}\sin\theta\sin\varphi + \frac{\pi}{4}\cos\theta$
9	$\frac{5}{12}\lambda$	$\frac{7}{12}\lambda$	$\frac{\sqrt{3}}{12}\lambda$	$-\frac{\lambda}{2}$	$\frac{\sqrt{3}\pi}{6}\sin\theta\sin\varphi - \pi\cos\theta$
10	$\frac{7}{12}\lambda$	$\frac{9}{12}\lambda$	$\frac{3\sqrt{3}}{8}\lambda$	$\frac{3}{8}\lambda$	$\frac{3\sqrt{3}\pi}{4}\sin\theta\sin\varphi + \frac{3\pi}{4}\cos\theta$
11	$\frac{9}{12}\lambda$	$\frac{11}{12}\lambda$	$-\frac{3}{8}\lambda$	$-\frac{3\sqrt{3}}{8}\lambda$	$-\frac{3\pi}{4}\sin\theta\sin\varphi - \frac{3\sqrt{3}\pi}{4}\cos\theta$
12	$\frac{11}{12}\lambda$	λ	λ	$\frac{\sqrt{3}}{12}\lambda$	$2\pi\sin\theta\sin\varphi + \frac{\sqrt{3}\pi}{6}\cos\theta$

#	$\vec{\ell}_i$		ℓ_r	ℓ_θ	ℓ_ϕ
	\vec{y}_i	\vec{z}_i			
0	-1	0	$-\sin\theta\sin\varphi$	$-\cos\theta\sin\varphi$	$-\cos\varphi$
1	$\frac{1}{2}$	$-\frac{\sqrt{3}}{2}$	$\frac{1}{2}\sin\theta\sin\varphi - \frac{\sqrt{3}}{2}\cos\theta$	$\frac{1}{2}\cos\theta\sin\varphi + \frac{\sqrt{3}}{2}\sin\theta$	$\frac{1}{2}\cos\varphi$
2	$-\frac{\sqrt{3}}{2}$	$\frac{1}{2}$	$-\frac{\sqrt{3}}{2}\sin\theta\sin\varphi + \frac{1}{2}\cos\theta$	$-\frac{\sqrt{3}}{2}\cos\theta\sin\varphi - \frac{1}{2}\sin\theta$	$-\frac{\sqrt{3}}{2}\cos\varphi$
3	0	-1	$-\cos\theta$	$\sin\theta$	0
4	$\frac{\sqrt{3}}{2}$	$\frac{1}{2}$	$\frac{\sqrt{3}}{2}\sin\theta\sin\varphi + \frac{1}{2}\cos\theta$	$\frac{\sqrt{3}}{2}\cos\theta\sin\varphi - \frac{1}{2}\sin\theta$	$\frac{\sqrt{3}}{2}\cos\varphi$
5	$-\frac{1}{2}$	$-\frac{\sqrt{3}}{2}$	$-\frac{1}{2}\sin\theta\sin\varphi - \frac{\sqrt{3}}{2}\cos\theta$	$-\frac{1}{2}\cos\theta\sin\varphi + \frac{\sqrt{3}}{2}\sin\theta$	$-\frac{1}{2}\cos\varphi$
6	1	0	$\sin\theta\sin\varphi$	$\cos\theta\sin\varphi$	$\cos\varphi$
7	$-\frac{1}{2}$	$\frac{\sqrt{3}}{2}$	$-\frac{1}{2}\sin\theta\sin\varphi + \frac{\sqrt{3}}{2}\cos\theta$	$-\frac{1}{2}\cos\theta\sin\varphi - \frac{\sqrt{3}}{2}\sin\theta$	$-\frac{1}{2}\cos\varphi$
8	$\frac{\sqrt{3}}{2}$	$-\frac{1}{2}$	$\frac{\sqrt{3}}{2}\sin\theta\sin\varphi - \frac{1}{2}\cos\theta$	$\frac{\sqrt{3}}{2}\cos\theta\sin\varphi + \frac{1}{2}\sin\theta$	$\frac{\sqrt{3}}{2}\cos\varphi$
9	0	1	$\cos\theta$	$-\sin\theta$	0
10	$-\frac{\sqrt{3}}{2}$	$-\frac{1}{2}$	$-\frac{\sqrt{3}}{2}\sin\theta\sin\varphi - \frac{1}{2}\cos\theta$	$-\frac{\sqrt{3}}{2}\cos\theta\sin\varphi + \frac{1}{2}\sin\theta$	$-\frac{\sqrt{3}}{2}\cos\varphi$
11	$\frac{1}{2}$	$\frac{\sqrt{3}}{2}$	$\frac{1}{2}\sin\theta\sin\varphi + \frac{\sqrt{3}}{2}\cos\theta$	$\frac{1}{2}\cos\theta\sin\varphi - \frac{\sqrt{3}}{2}\sin\theta$	$\frac{1}{2}\cos\varphi$
12	-1	0	$-\sin\theta\sin\varphi$	$-\cos\theta\sin\varphi$	$-\cos\varphi$

The total number of 96 segments for the whole antenna, where all sides had equal number of points, was selected for the simulation, after the investigation for 13, 24, 48, 72, 96, 120, 144, 168, 192, 216, 240 segments. The above mentioned characteristics remained almost constant after this number of 96 segments. An appropriate computer program was developed in Fortran to create the input file with antenna geometry for [RICHWIRE].

A very good agreement between simulated and analyti-

cal produced radiation patterns is shown in Fig. 5 for the three main planes in 1111 [MHz], although there is a point for discussion here. A closer examination, after 7 years from the initial work [1], of what was really compared in Fig. 5, proved that the analytical patterns illustrated corresponds to rather an upper bound of the absolute radiation pattern since it results from the sum of the 13 absolute radiation patterns and not from the total absolute radiation pattern.

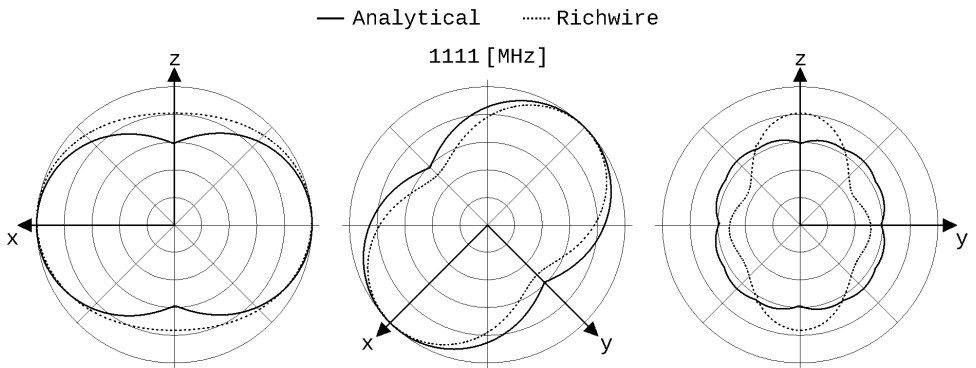

Fig. 5: Radiation patterns in 1111 [MHz]

Furthermore, the simulation model, as it is shown in Fig. 6, consists inevitable not in four equal delta elements but in four truncated ones, as care must be taken

- a) to avoid the overlapping of the wires in a future construction and
- b) to reduce the strong cou-

pling caused by the proximity effect.

Thus, the minimum permitted square region with side $(2a+a/10)$, where "a" is the used wire radius, was removed from the center intersection point of the four delta elements, while in the same time, in order to achieve the

connection of the neighboring sides, the base angles of every element are slightly greater than 60° , and the total length of such formed element was slightly greater than the initial $\lambda/2$.

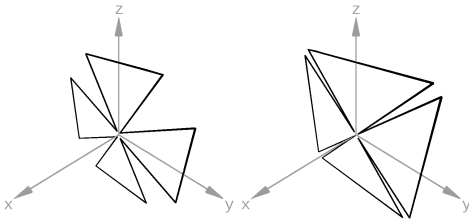

Fig. 6: Simulation models

Extremely high values of Standing Wave Ratio [SWR] in 1111 [MHz] for the three characteristic impedances 50, 75 and 300 $[\Omega]$ as it is shown

in Fig. 7, made clear the need for further research on the antenna's geometry.

The antenna was modified only with respect to the base angles for constant delta-perimeter, resulting a Delta-cross Loop antenna of four isosceles triangles. A computer program was also developed in Fortran producing the corresponding input data for [RICHWIRE].

The investigation was performed from the value of 48° for the base angles to 78° in step of 1° at the frequency of 1111 [MHz]. The best performance was noticed between 48° and 52° and the model, shown in Fig. 8, with 48° base angles was selected.

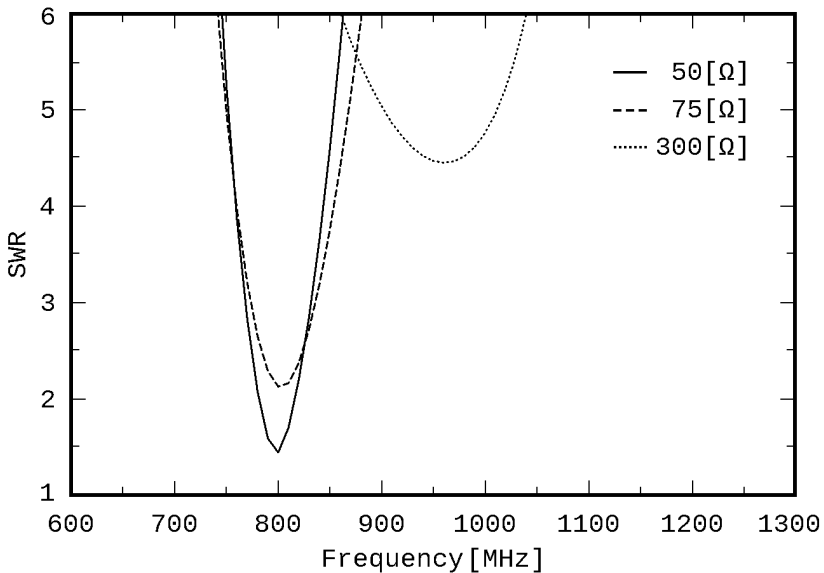

Fig. 7: Standing Wave Ratio against frequency

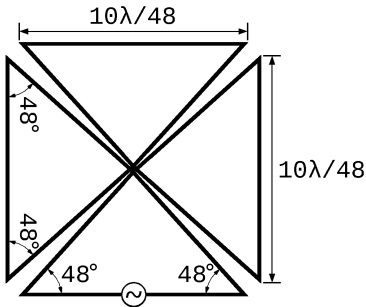

Fig. 8: Improved antenna

In Figs. 9 - 13 SWR, Input Impedance [Z_{in}] as Input Resistance R_{in} and Input Reactance X_{in} in [Ω] and Directivity D in [dB] of the improved antenna together with that of the initial one and of 2λ dipole, are shown respectively. Fig. 12 shows a properly selected window of the total frequency range for the Input Impedance in order to clarify the improvement of the modified antenna. In Figs. 14 - 15 a comparison of the radiation patterns of the three antennas is given at five frequencies in the three main planes zOx , xOy and yOz . In Fig. 16 the 3D analytical radiation pattern at 1111 [MHz] and in Fig. 17 the corresponding 3D patterns in all frequencies are shown.

Conclusion

Although, the agreement of results between simulation and analysis was very good,

the characteristics of the initial antenna were not satisfactory. An improvement process was needed and the research was here limited to the change of the base angles only to the rather small range of -12° , $+18^\circ$ around the initial 60° base angle. Thus, the improved antenna had the best performance about 100 MHz lower of the desired frequency of 1111 [MHz], as it is shown in Figs. 9 - 13. The SWR for the 50 [Ω] characteristic impedance has its best value closer to 1111 [MHz] while the initial antenna and the 2λ dipole of equivalent length had a relative small value of SWR at about 800 [MHz] (Fig. 9). It is also obvious that the Input Impedance as well as Directivity is relatively stable and slightly better for the improved antenna and much better from the initial one (Figs. 10 - 13). Corresponding values for SWR, Input Impedance and Directivity for the three antennas are given in Tab. 2.

The radiation pattern of the improved antenna is closer to that of a centered fed sinusoidal $\lambda/2$ dipole, avoiding the dispersion of radiation in multiple directions of the rather long 2λ dipole antenna (Figs. 14 - 15, 17).

Tab. 1: SWR, D, Z_{inp}

	SWR	D [dB]	Z_{inp} [Ω]
1111 [MHz]			
60°	43.7	2.49	40 - i 287
2 λ	26.1	4.09	577 - i 647
48°	6.55	3.10	70 + i 127
800 [MHz]			
60°	1.44	2.61	36 + i 5
2 λ	2.55	3.21	88 - i 52
48°	42.7	2.30	24 - i 219
1010 [MHz]			
60°	29.6	2.85	1297 + i 485
2 λ	20.4	3.74	993 + i 168
48°	1.26	2.90	40 + i 3

An extensive investigation concerning the analytical determination of the antenna radiation pattern and its normalized absolute values is in the immediate future plans of the authors in order to achieve the clarification of its relation with the one produced by simulation.

A wider range of the base angle variation or the variation of the total length of each delta element are some design ideas for a future research work. Nevertheless, the final step is, without doubt, the construction and measurement of the proposed antenna together with the comparison of the corresponding results.

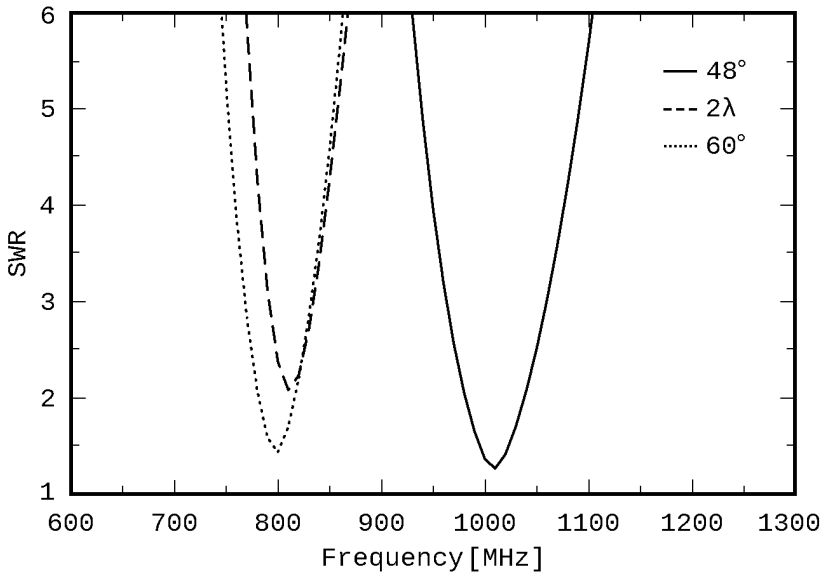

Fig. 9: SWR for improved-48°, 2 λ and initial-60° antenna

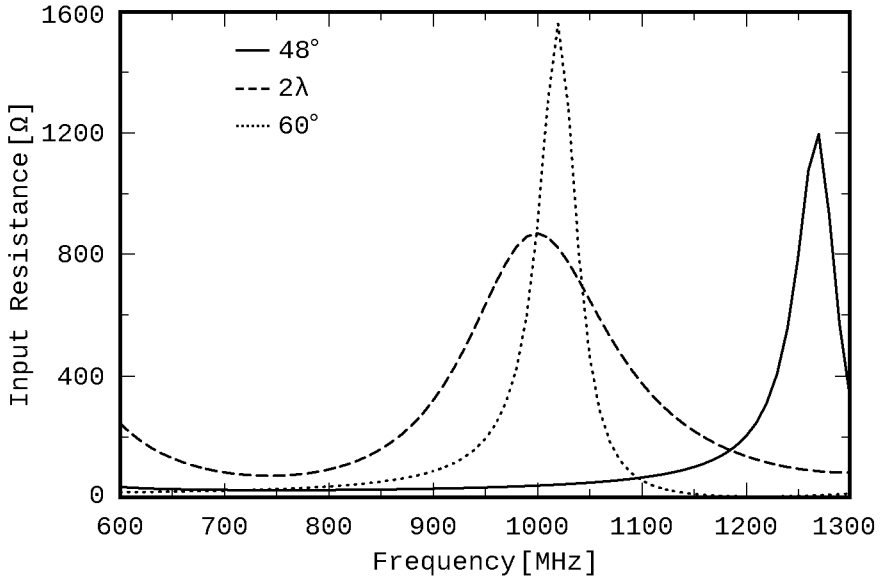

Fig. 10: R_{inp} for improved-48°, 2λ and initial-60° antenna

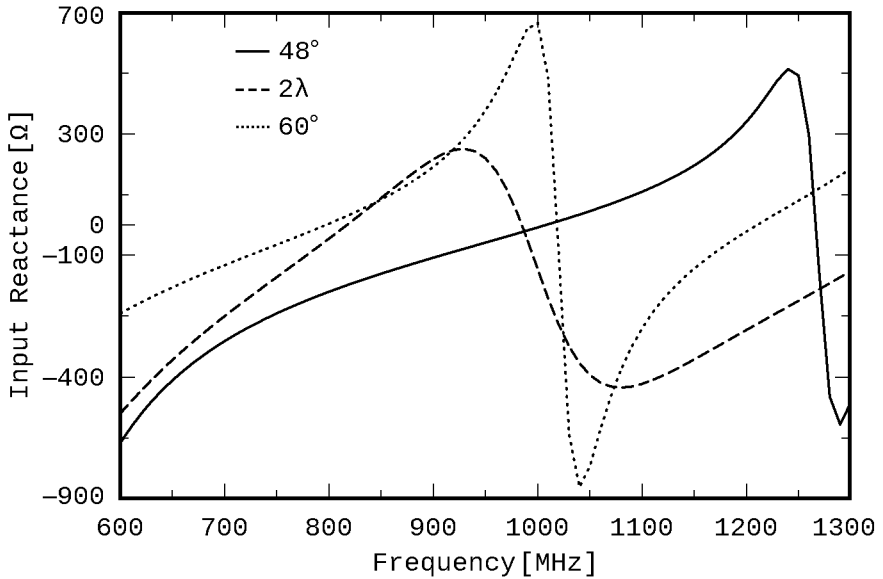

Fig. 11: X_{inp} for improved-48°, 2λ and initial-60° antenna

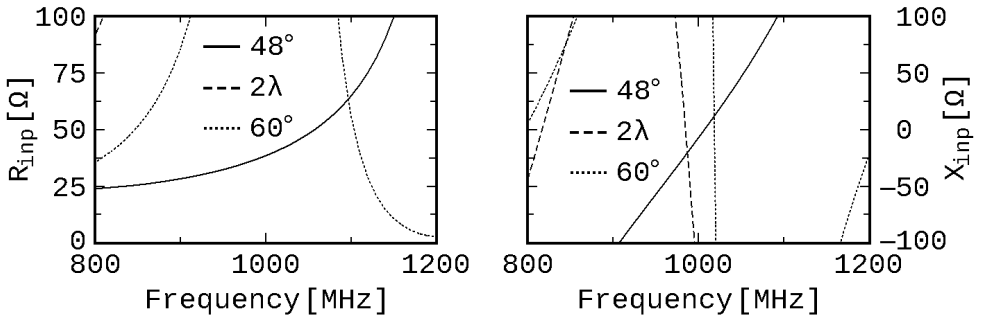

Fig. 12: R_{in} , X_{in} for the three antennas in [800, 1200] MHz

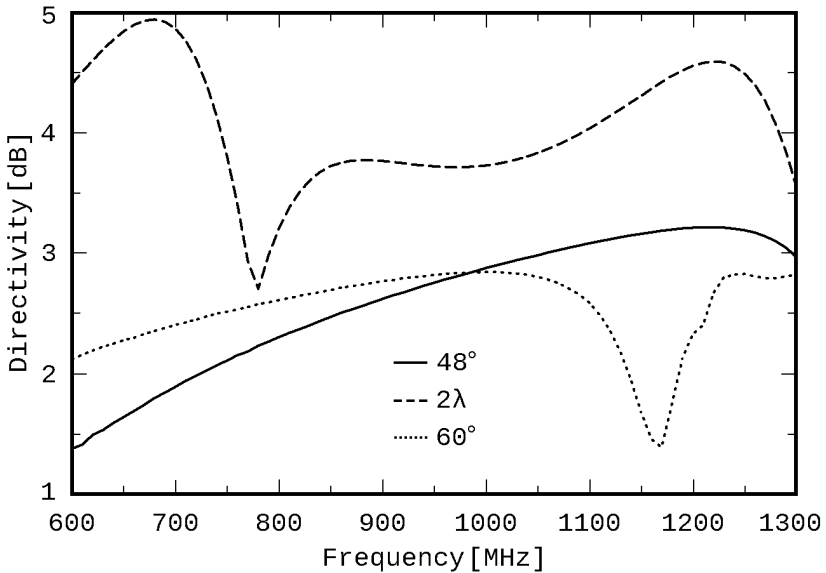

Fig. 13: Directivity of the three antennas

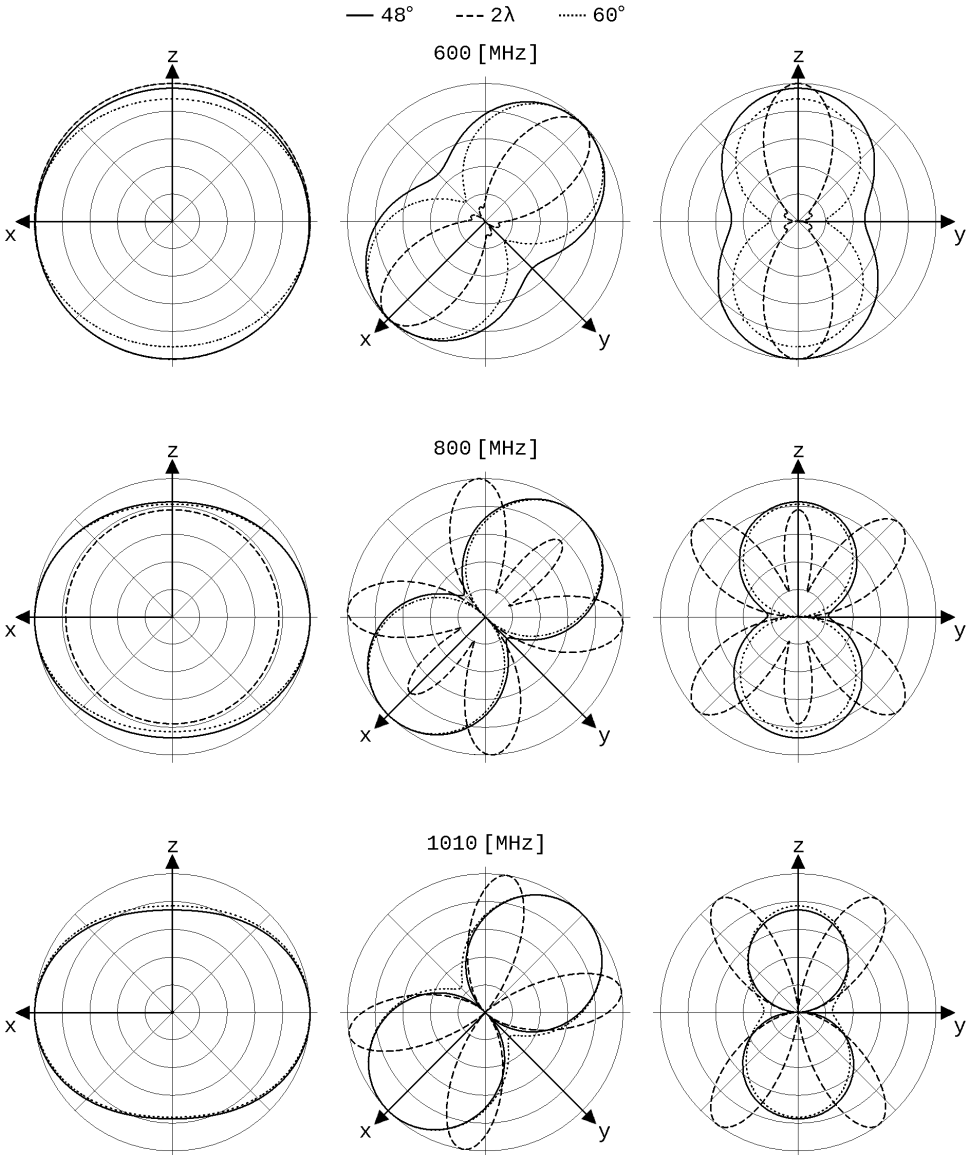

Fig. 14: Radiation patterns at 600, 800 and 1010 [MHz]

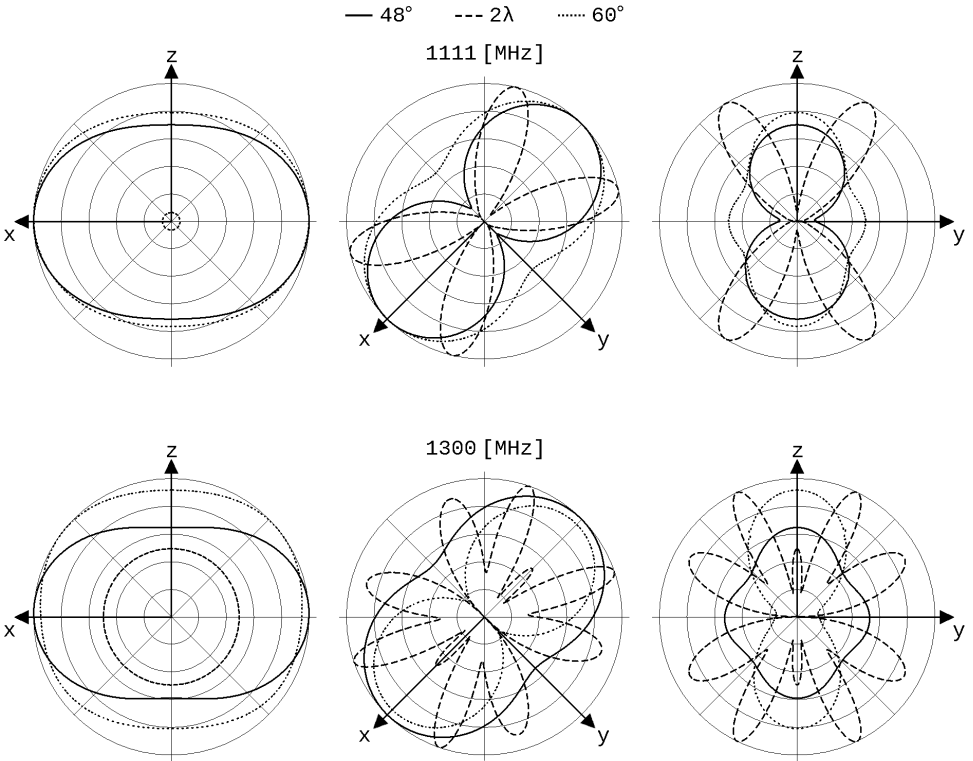

Fig. 15: Radiation patterns at 1111 and 1300 [MHz]

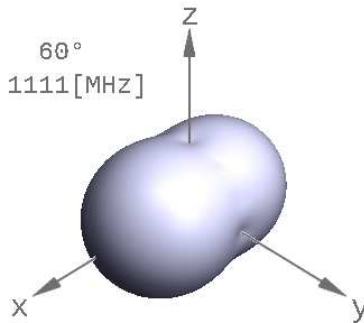

Fig. 16: 3D Analytical Radiation Pattern

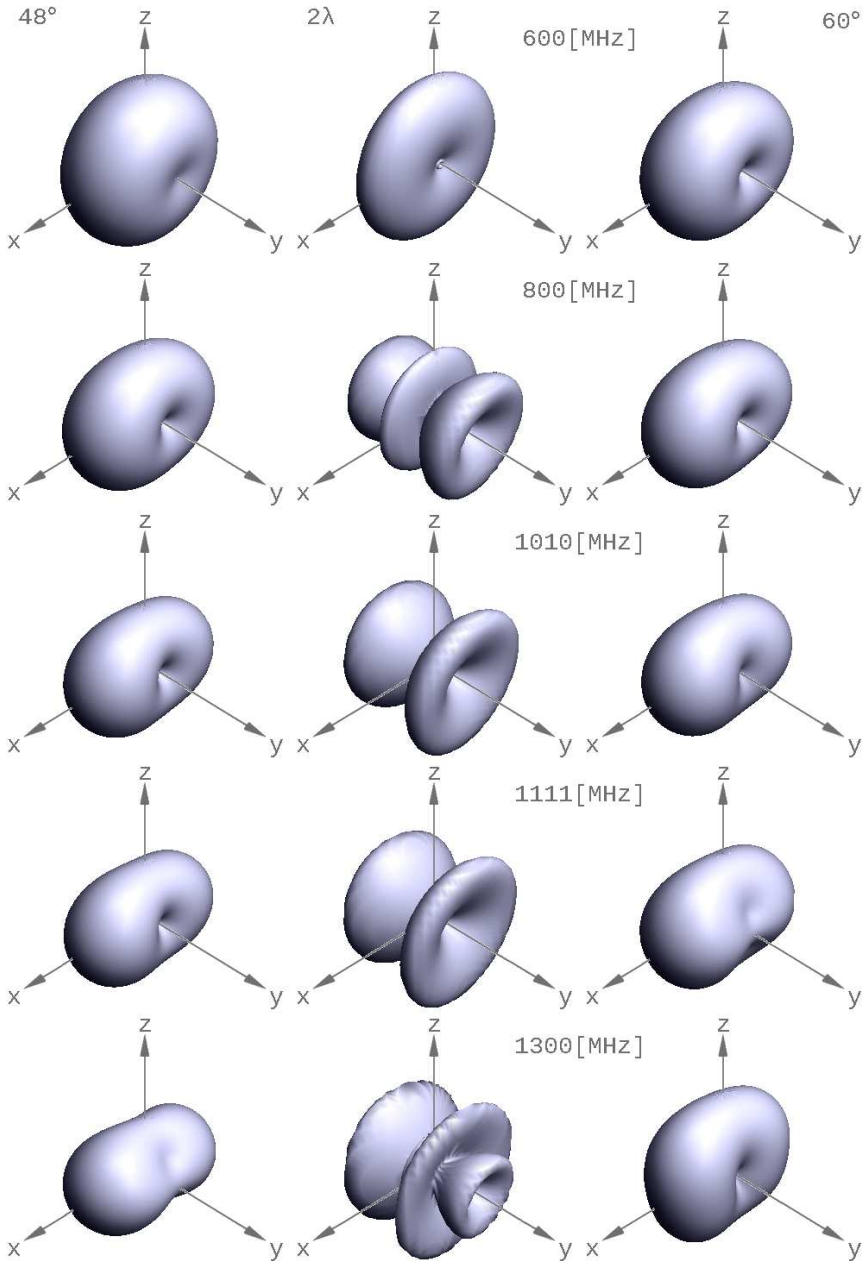

Fig. 17: 3D Simulated Radiation Patterns

References *

- [1] Papadaniel G., "The Eisernes Kreuz Antenna [Prototype ARG-06]", Diploma Thesis #40, ARG-Antennas Research Group, DUTH, 2007 (in Greek)
 - [2] Zimourtopoulos P., "Antenna Notes 1999-, Antenna Design Notes 2000-", "www.antennas.gr/antennanotes/" (in Greek)
 - [3] Yannopoulou N., Zimourtopoulos P., "A FLOSS Tool for Antenna Radiation Patterns", Proceedings of 15th Conference on Microwave Techniques, COMITE 2010, Brno, Czech Republic, pp. 59-62
 - [4] Richmond J.H., "Computer program for thin-wire structures in a homogeneous conducting medium", Publication Year: 1974, NTRS-Report/Patent Number: NASA-CR-2399, ESL-2902-12, DocumentID: 19740020595, "<http://ntrs.nasa.gov/>"
 - [5] Yannopoulou N., Zimourtopoulos P., "Mini Suite of Antenna Tools", Educational Laboratories, Antennas Research Group, 2006, "www.antennas.gr/antsoft/minisuiteoftools/"
 - [6] Yannopoulou N.I., "Study of monopole antennas over a multi-frequency decoupling cylinder", PhD Thesis, EECE, DUTH, February 2008 (in Greek), pp. (2-6)-(2-9)
- *Active Links: 27.05.2015 - Inactive Links : FTP#J Link Updates: "<http://updates.ftpj.otoiser.org/>"

Follow-Up Research Paper

Not until now

Previous Publication in FUNKTECHNIKPLUS # JOURNAL

"Visual EM Simulator for 3D Antennas: VEMSA3D – FLOSS for MS Windows", Issue 6, Year 2, pp. 7-25

* About The Authors

Nikolitsa Yannopoulou, Issue 1, Year 1, p. 15

Petros Zimourtopoulos, Issue 1, Year 1, p. 15

Papadaniel Glykeria, was born in Rodolivos-Amfipolis, Serres, Greece in 1981. She graduated from Electrical Engineering and Computer Engineering in 2007 from Democritus University of Thrace, Xanthi, Greece. Member of Antennas Research Group while she was elaborated her diploma thesis. She did practice exercise in the Hellenic Telecommunication Organisation and she worked as an Engineer in Clima, Voltampere Energy and Rodax Companies for the study/design of Photovoltaic systems, wind farms, natural gas plants and electrical installations in a thermoelectric power station. She is a certified three-dimensional graphics and computer aided Designer.

g.papadaniel@yahoo.gr

[This Page Intentionally Left Blank]

[This Page Intentionally Left Blank]

[This Page Intentionally Left Blank]

In case of any doubt,
download the genuine papers from
genuine.ftpj.otoiser.org

FRONT COVER VIGNETTE

A faded synthesis of an anthemion rooted in a meandros

The thirteen-leaf is a symbol for a life tree leaf.
"Herakles and Kerberos", ca. 530–500 BC,
by Paseas, the Kerberos Painter,
Museum of Fine Arts, Boston.

www.mfa.org/collections/object/plate-153852

The simple meandros is a symbol for eternal immortality.
"Warrior with a phiale", ca. 480–460 BC,
by Berliner Maler,
Museo Archeologico Regionale "Antonio Salinas" di Palermo.

commons.wikimedia.org/wiki/File:Warrior_MAR_Palermo_NI2134.jpg